

August 2020

**SAILSetc**  
RIGGING PLAN  
RP14LW

# Marblehead

## *Lightweight swing rig rigging plan standard version*

### Description

### SAILSetc code

*The following sheets are collated into this booklet*

Marblehead lightweight swing rig dimensions

Mast construction

RP-MLWSR-1

Mast head fittings, main halyard & backstay,  
headsail halyard

RP-MLWSR-2

Main boom & swing rig block – aft

RP-MLWSR-3

Main boom & swing rig block – fore

RP-MLWSR-4

Foreyard & headsail boom – aft

RP-MLWSR-5

Foreyard & headsail boom – fore

RP-MLWSR-6

Terminations for wire & line

RP-GEN-1&2

*Please note that the numbers placed in circles on the plan sheets relate to the numbered instructions in the **kit instructions, KI14LW**. The numbers placed in circles are not SAILSetc codes for those products.*

*end*

MARBLEHEAD LIGHTWEIGHT SWING RIG		length of lower reinforcement section of mast	14	12	10	8	8	10	10	8	10	10	12	5	5	5	nominal mainsail luff length	top of mast to bottom of upper limit mark	top of mast to bottom of middle limit mark	top of mast to top of middle mast section	top of mast to strut	top of mast to top of lower limit mark	top of mast to top of block/bottom of short tube	top of mast to deck	length of wire backstay

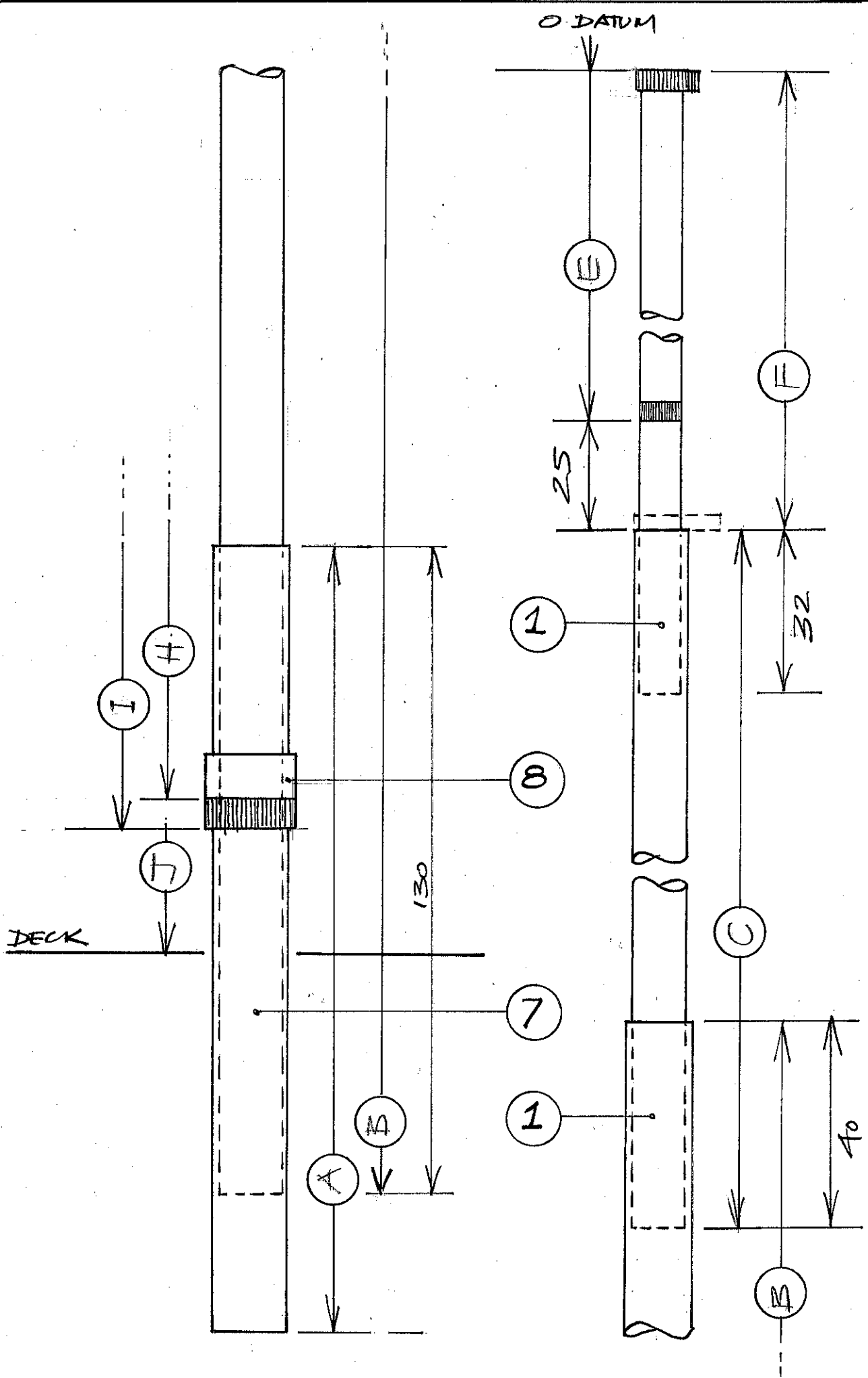

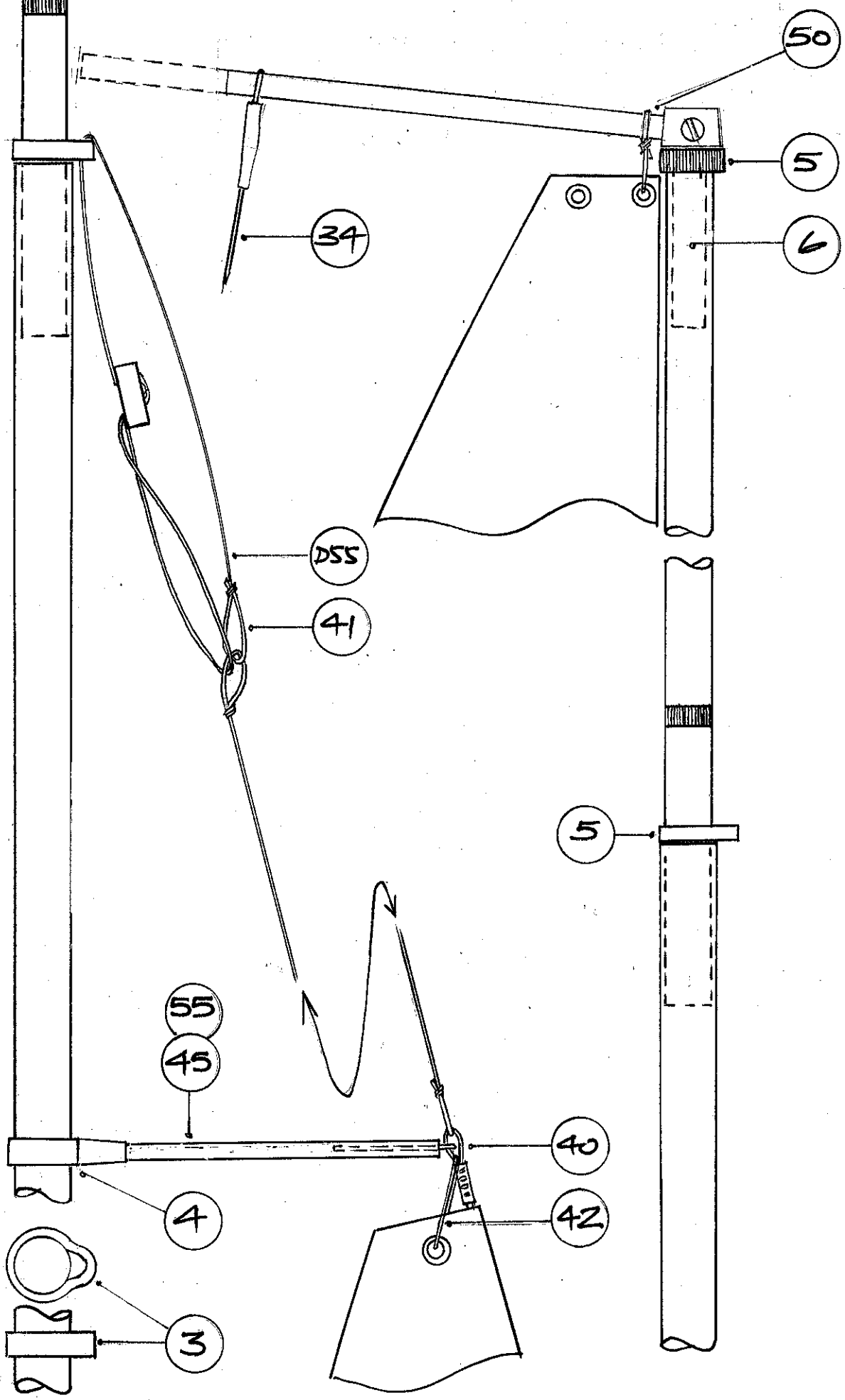

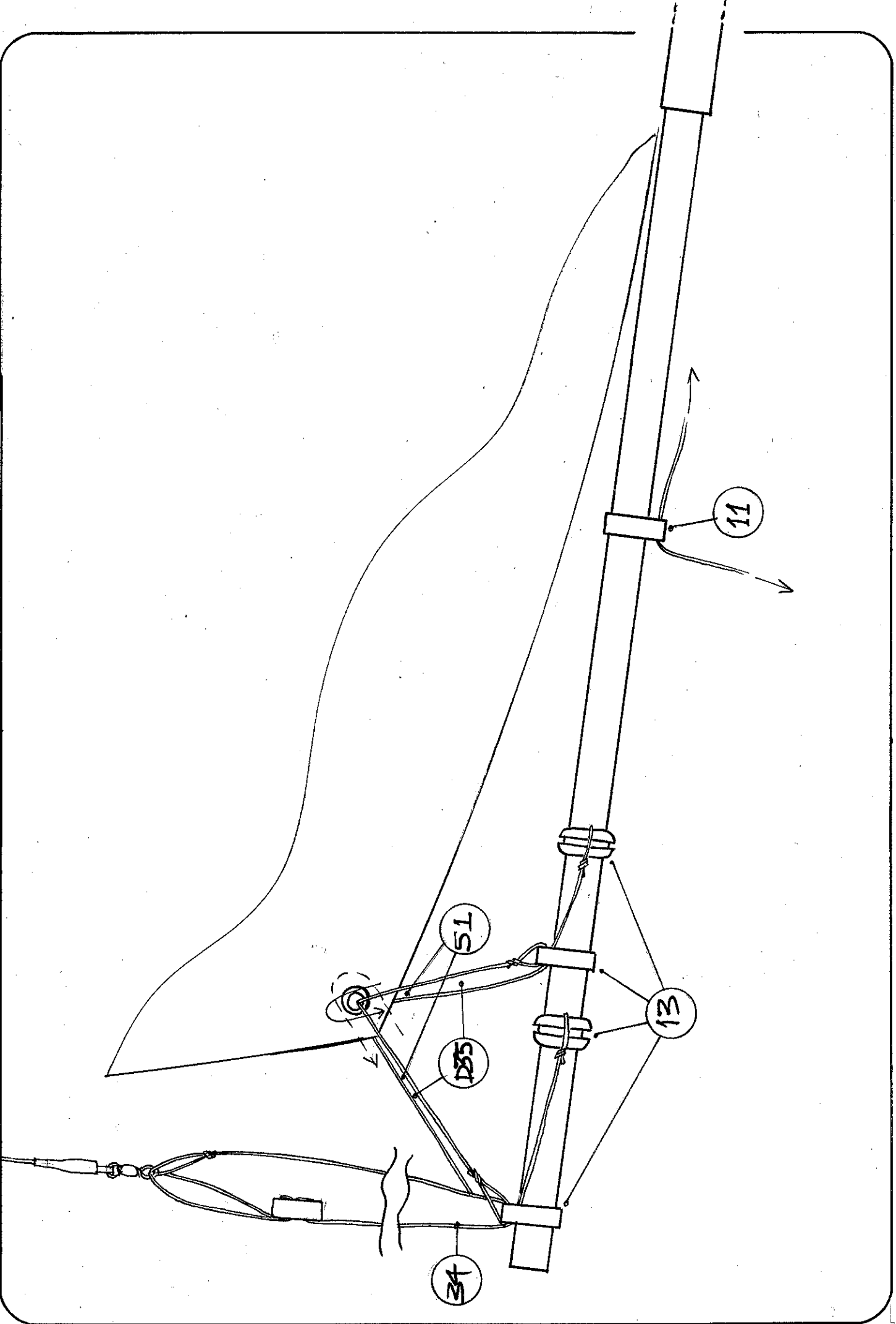

MAIN BOOM & SWING RIG BLOCK - FORE PART

RP-MLWSR-4

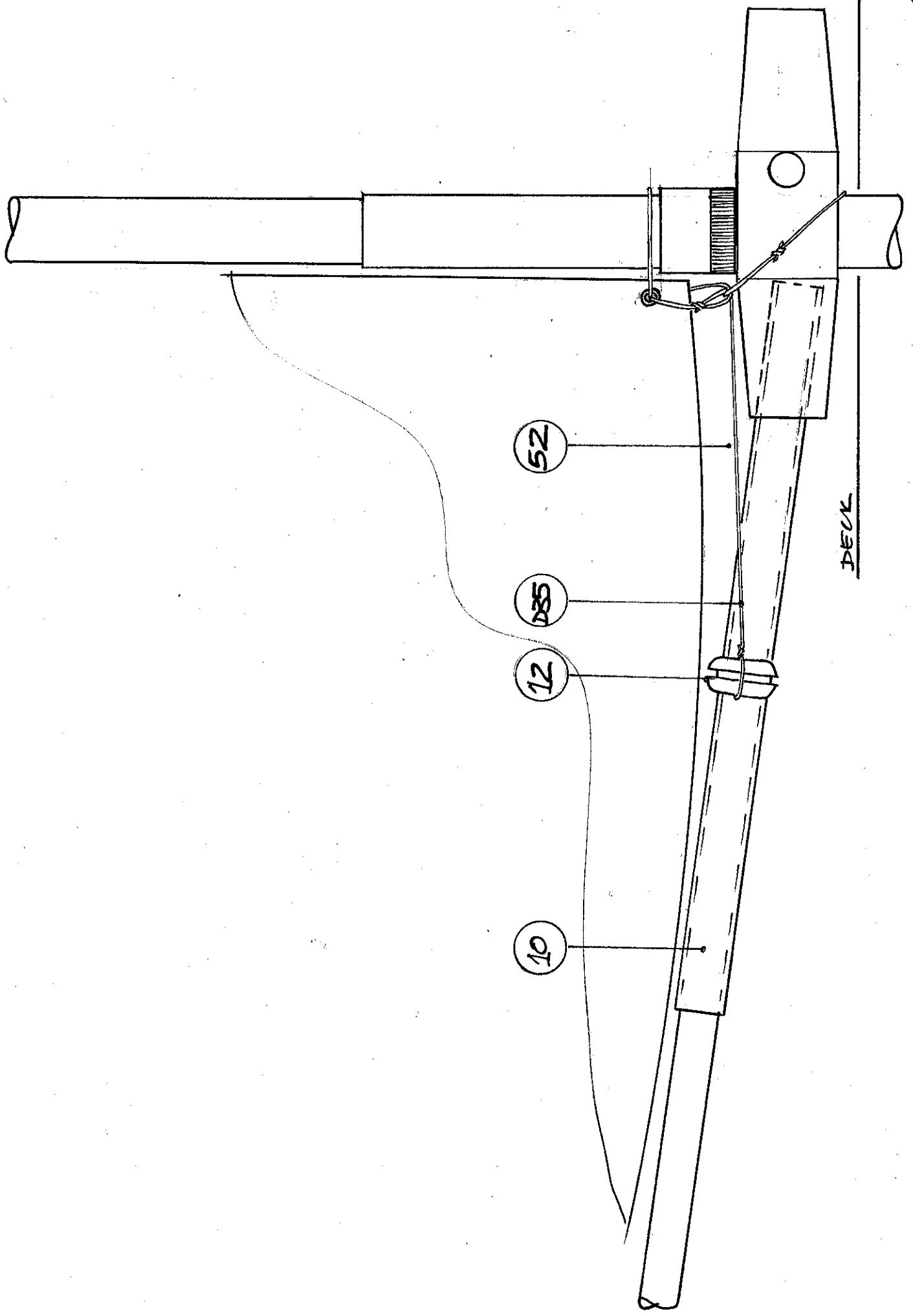

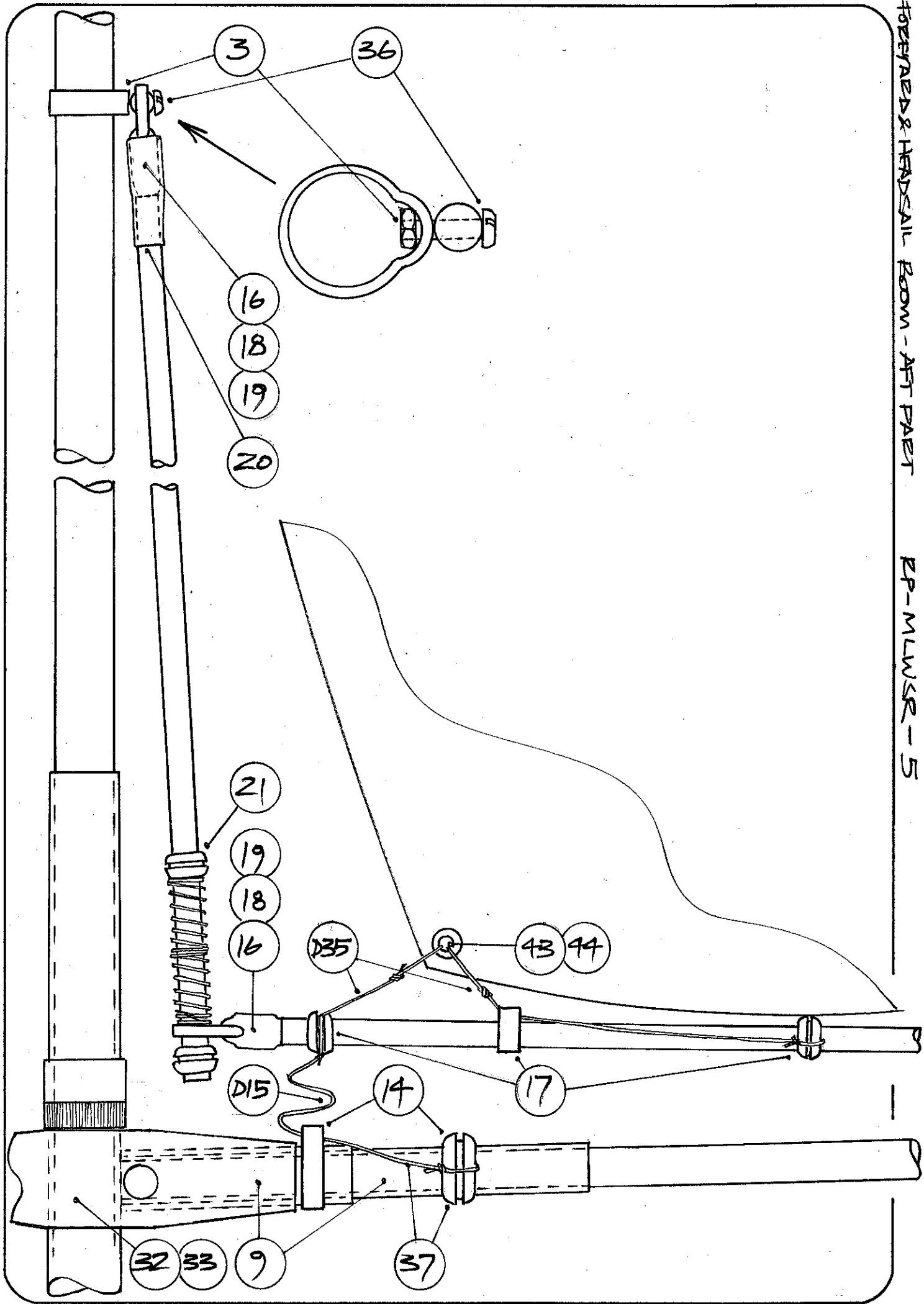

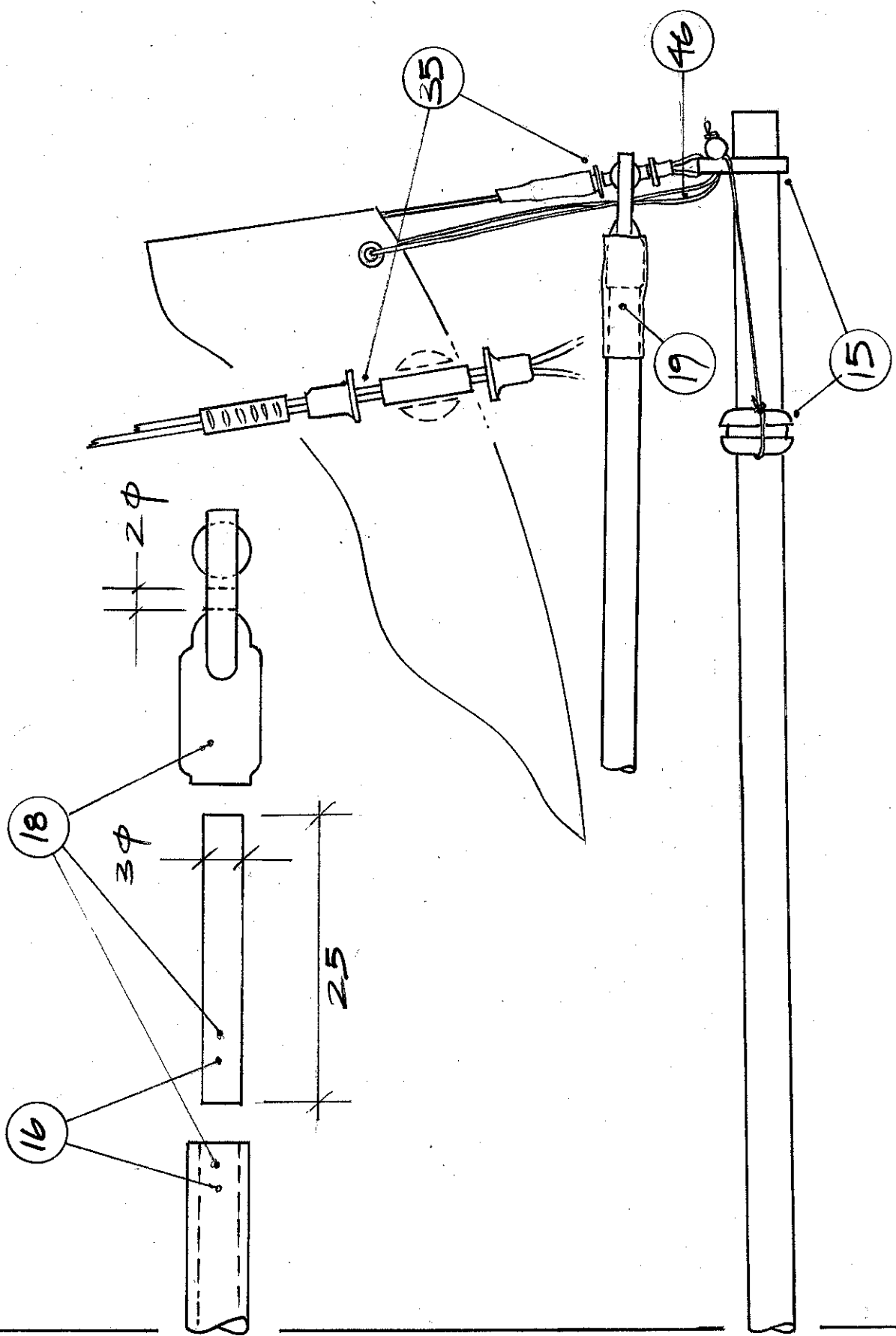



• DYNEMA

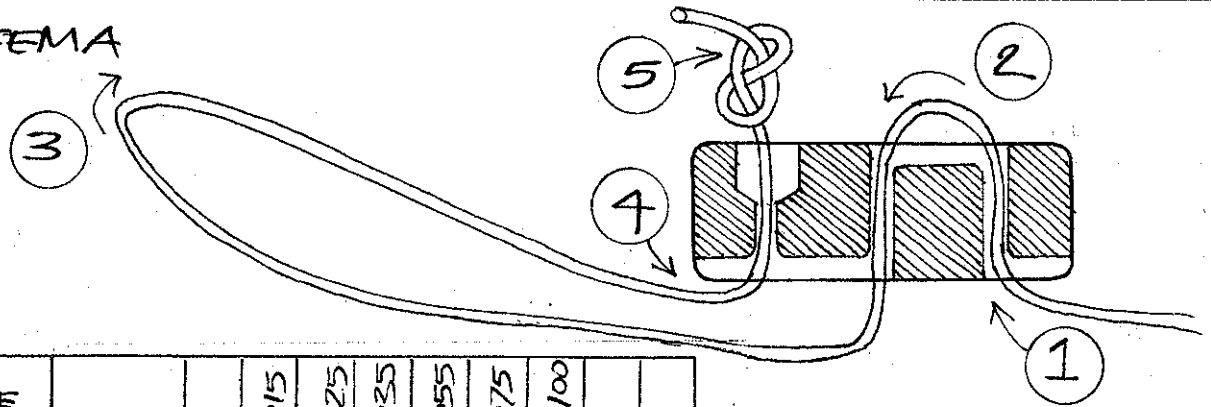

BOWS/E		D15	D25	D35	D55	D75	D100
SMALL	57-120		✓	✓	✓	✓	
LARGE	57-150					✓	✓

• FLAT WIRE

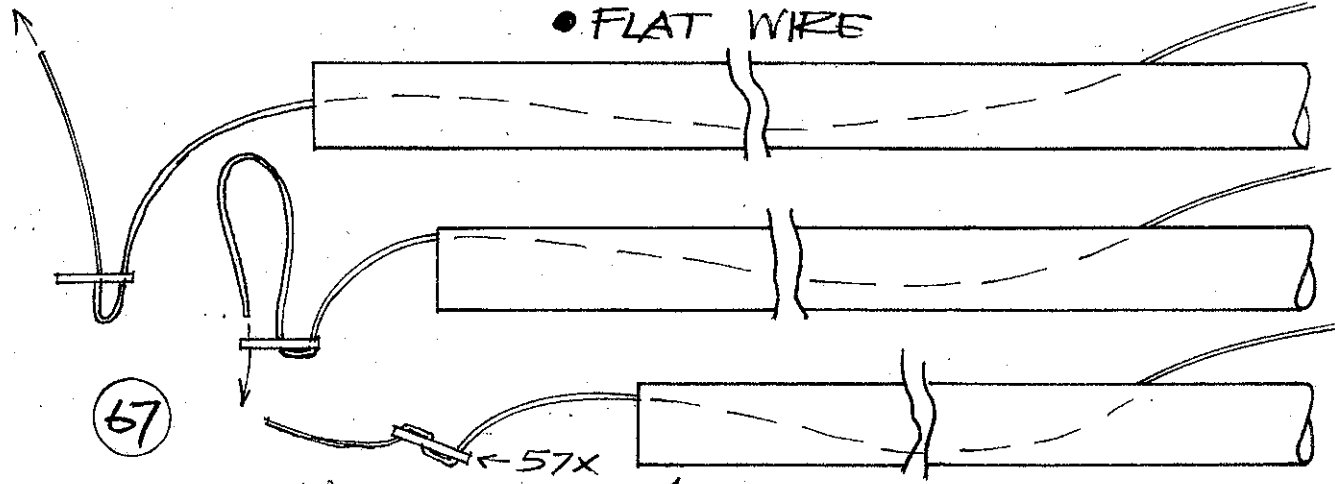

67

• SEVEN STRAND WIRE

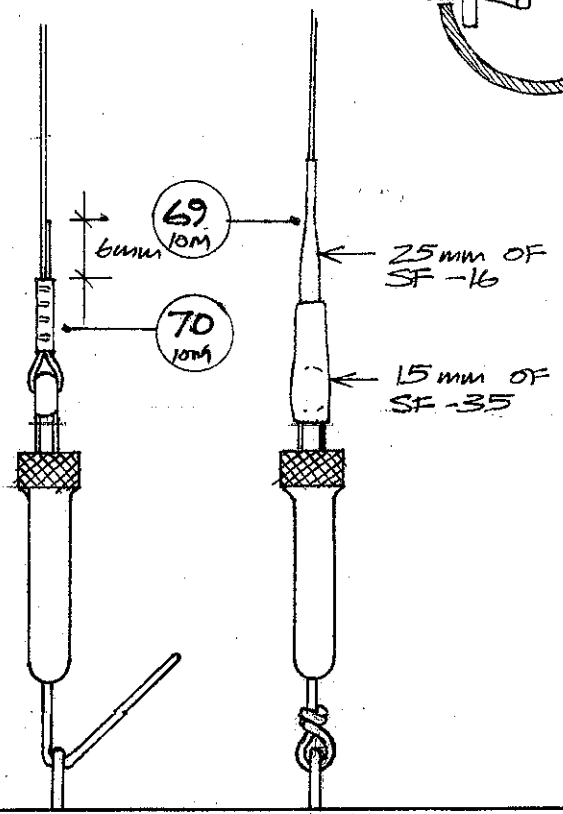

• FLAT WIRE

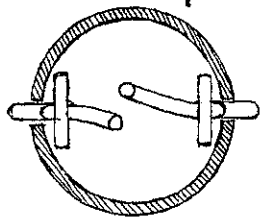

- A
- B
- C
- D
- E

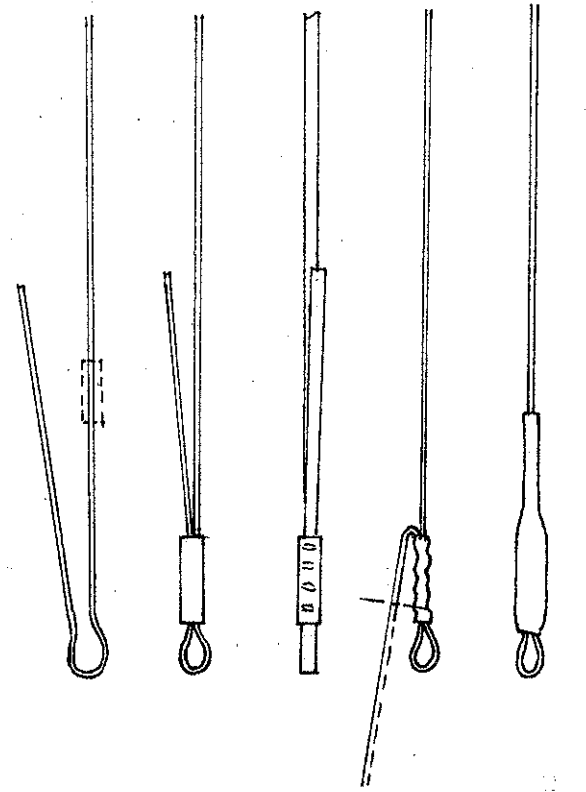

• STRAIGHT WIRE

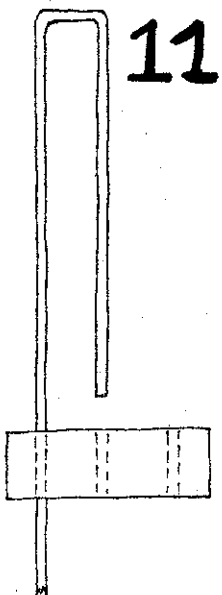

11

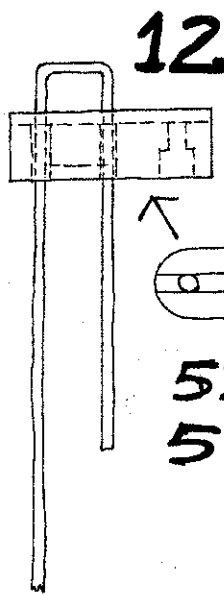

12

57-120  
57-150

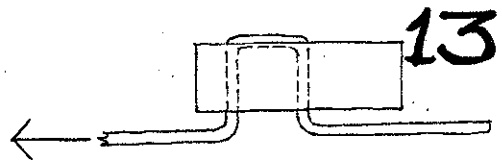

13

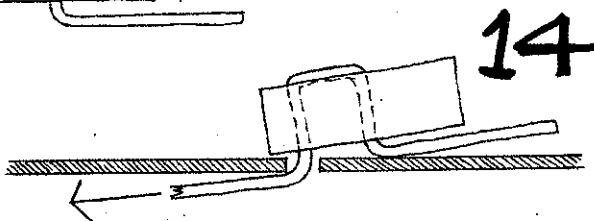

14

15

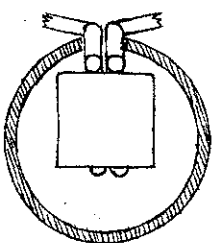

16

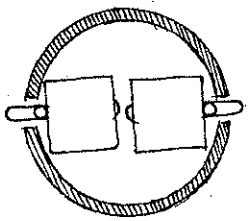

• STRAIGHT WIRE

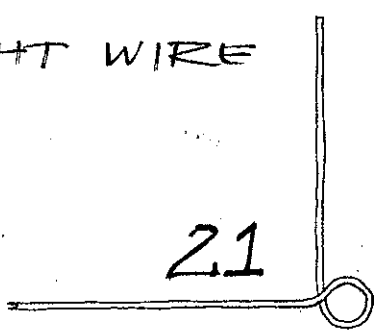

21

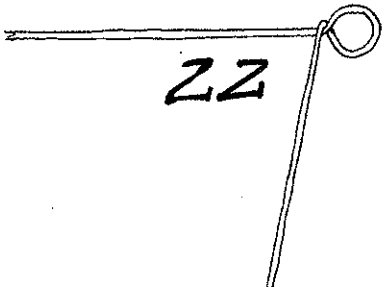

22

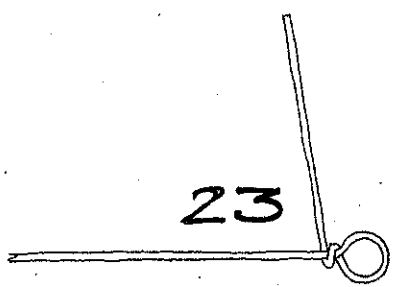

23

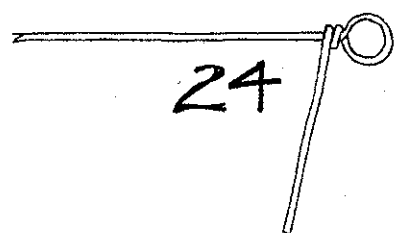

24

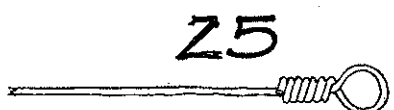

25